

ENERGYMID

Electronic Energy Meters

Direct conn. EM2281/EM2289

Transformer conn. EM2381/2387/2389

3-349-868-03
5/3.19

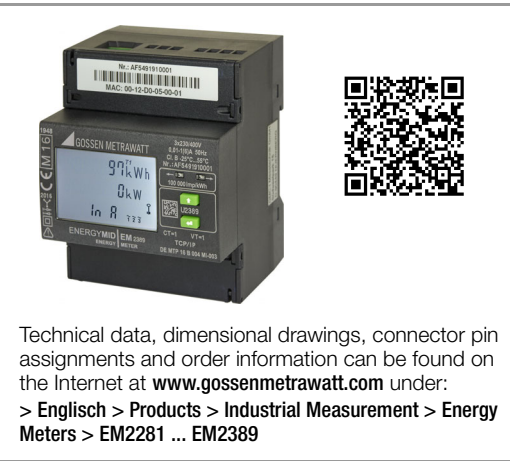

1 Scope of Delivery

- Energy meter
- Operating instructions (German and English)
- Calibration certificate (with feature P9 only)

Operating instructions including safety precautions can be found in each respective language at www.gossenmetrawatt.com/english/produkte/em2281-em2389.htm
> Operating Instructions >> GB >> F >> I

2 Safety Precautions – Symbols

- Check the specified nominal voltage on the serial plate before placing the instrument into service.
- Observe maximum pulse output voltage.
- When wiring the instrument, make sure the connector cables are not damaged, and that they are voltage-free.
- If it can be assumed that safe operation is no longer possible, the instrument must be immediately removed from service (disconnect input voltage!). Safe operation can no longer be relied upon if the instrument demonstrates visible damage.
- The device may not be placed back into operation until troubleshooting and repair have been performed, and calibration and dielectric strength have been tested and approved at our factory or an authorized service center.
- Voltage conducting parts may be exposed if the cover is opened.
- If balancing, maintenance or repair of a live open instrument is required, this may only be carried out by trained personnel who are familiar with the dangers involved.
- When connecting measuring current, it is important to provide for low-ohmic contact and to select an appropriate conductor diameter.

Meanings of Symbols on the Instrument

DE MTP 17 B 002 MI-003 (EM228x)
DE MTP 16 B 004 MI-003 (EM238x)
Prototype test certificate

Total insulation, protection class II device

Warning concerning a point of danger (attention, observe documentation!)

This device may not be disposed of with the trash. Further information can be accessed on the Internet at www.gossenmetrawatt.com by entering the search term "WEEE".

Metrology mark with indication of year (M16) and register no. of the notified body for module D, country-specific calibration validity period

Marking with stamp of the federally approved test laboratory (for recalibration only)

Tamper-Proof Sealing – Opening the Meter / Repairs

Tamper-Proof Calibration Sealing with Manufacturer's Seal (at the side)

If the manufacturer's seal is damaged or removed, all guarantee claims are rendered null and void.

The meter may only be opened by authorized, trained personnel in order to ensure flawless operation and to assure that the guarantee is not rendered null and void.

If it can be ascertained that the meter has been opened by unauthorized personnel, no guarantee claims can be honored by the manufacturer with regard to personal safety, measuring accuracy, compliance with applicable safety measures or any consequential damages.

Tamper-proof sealing for the terminal cover may be attached either to the left or the right of the terminal cover.

3 Rating Plate Entries

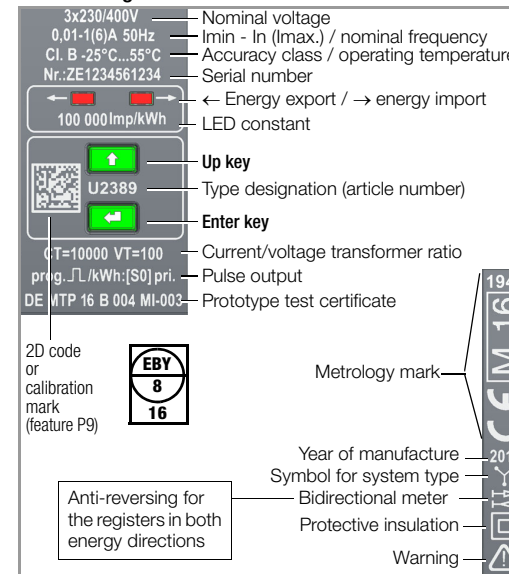

4 Connector Pin Assignments and Wire Gauge

Note: Observe the wiring diagrams in the top and bottom terminal covers.

Connections	Direct, EM228X	Transformer, EM238X
Current input	Solid wire ≤ 16 sq. mm Fine wire ≤ 25 mm ² or ≤ 16 mm ² with wire end ferrule Tightening torque: 3-4 Nm	Solid wire ≤ 4 sq. mm Tightening torque: 0,5-0,6 Nm
Voltage input	N: solid wire ≤ 2,5 sq. mm Tightening torque: 0,4 Nm	Solid wire ≤ 4 sq. mm Tightening torque: 0,5-0,6 Nm
S0 pulse output Bus output, tariff input (power utility pulse)	Solid wire ≤ 2,5 sq. mm Tightening torque: 0,4 Nm	Solid wire ≤ 2,5 sq. mm Tightening torque: 0,4 Nm
TCP/IP		RJ45 (8P8C)

Meas. Inputs, EM228X Direct Meter (top & bottom terminals)

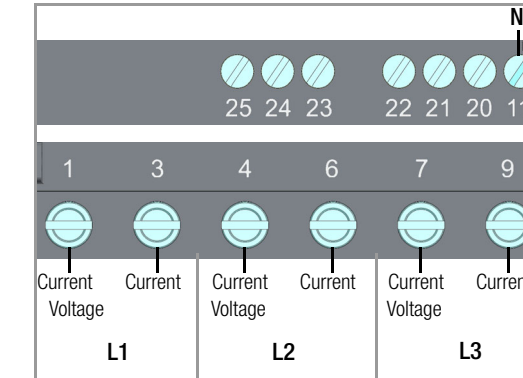

Meas. Inputs, EM238X Transf. Meter (bottom terminals)

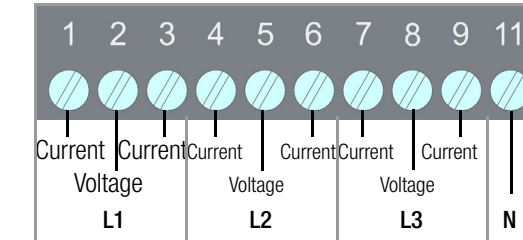

Connections (top terminals)

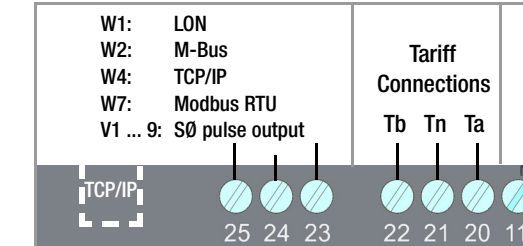

5 Pulse Output – Bus Interfaces

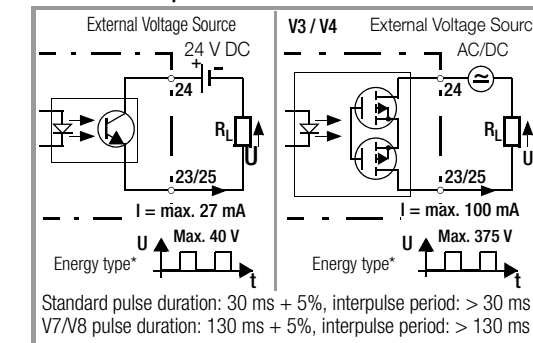

Standard pulse duration: 30 ms + 5%, interpulse period: > 30 ms
V7/V8 pulse duration: 130 ms + 5%, interpulse period: > 130 ms

Default setting: active energy

Terminal 23 (S01) import, terminal 25 (S02) export
* Type of energy can also be selected with feature V2, V4.

Pulse Rates	V1/V3, fixed	V7	V8	V9, fixed	V2/V4, programmable
	[pulses per kWh]				
Direct	1000	100	—	—	1 ... 1000 pls/kWh
Transformer	U2381 / U238x f (secondary)				
CT x VT = 1 (Q0)	1000	100	1000	50000	1...1000...10,000 pls/kWh
CTxVT=1(Q0)U6/7	1000	100	1000	20000	1...1000...10,000 pls/kWh
CTxVT=1(Q0)U3	1000	100	1000	50000	1...1000...10,000 pls/kWh
CT, VT, progr. (Q1)	1000	100	1000	50000	1...1000...50,000 pls/kWh
CT, VT, progr. (Q1)U6/7	1000	100	1000	20000	1...1000...50,000 pls/kWh
CT, VT, progr. (Q1)U3	1000	100	1000	50000	1...1000...50,000 pls/kWh
CTxVT; CT, VT, fixed (Q9)	f (primary)				
2 ... 10	1000	100	—	—	1 ... 1000 pls/kWh
11 ... 100	100	10	—	—	0.1 ... 100 pls/kWh
101 ... 1000	10	1	—	—	0.01 ... 10 pls/kWh
1001 ... 10,000	1	100	—	—	1 ... 1000 pls/MWh
10,001 ... 100,000	0.1	10	—	—	0.1 ... 100 pls/MWh
100,001...1,000,000	0.01	1	—	—	0.01 ... 10 pls/MWh

Underlined values are default values.

Repair and Replacement Parts Service Recalibration

Recalibration can be conducted at any time by our federally approved test laboratory (EBY-8).

GMC-I Service GmbH
Service Center
Beuthener Straße 41
D-90471 Nürnberg, Germany
Phone +49-911-817718-0
Fax +49-911-817718-253
e-mail service@gossenmetrawatt.com
www.gmci-service.com

This address is only valid in Germany. Please contact our representatives or subsidiaries for service in other countries.

Industrial Product Support

If required please contact:

GMC-I Messtechnik GmbH
Industrial Product Support Hotline
Phone +49-911-8602-500
Fax +49-911-8602-340
e-mail support.industrie@gossenmetrawatt.com

6 Display and Control Panel

6.1 Test LEDs

The test LEDs are located above the control keys. The left-hand LED indicates energy export, and the right-hand LED energy import. LED blinking frequency increases along with measured power. If all currents are smaller than starting current, both LEDs light up continuously.

LED Constant

EM228x: 10,000 pls/kWh (direct meter)
EM238x: 100,000 pls/kWh (transformer meter)

6.2 Resolution, Main Display (large characters) Energy Import

Intern wird mit erhöhter Auflösung gezählt. Hierdurch kann bei Mehrtarifnutzung das Gesamtregister in der letzten Stelle einige Digit über der Summe der Einzelregister liegen.

Meter / Feature	CTxVT min.	CTxVT max.	Normal display	Calibration display *	Unit	
U2281, U2289	—	—	123456.78	23456.789	kWh	
U238x	Q0	1	12345.678	2345.6789	kWh	
		2	12345.678	2345.6789	kWh	
		4	12345.678	2345.6789	kWh	
	Q9	5	123456.78	34567.890	kWh	
		40	1234567.8	34567.890	kWh	
		400	12345678	345678.90	kWh	
Q1 **	4001	4000	12345678	345678.90	MWh	
		40000	12345678	34567.890	MWh	
		400000	12345678	34567.890	MWh	
	400001	1000000	12345678	345678.90	MWh	
		1	4	u12345.67	**	kWh
		5	40	u123456.7	**	kWh
4001	400	u1234567	**	kWh		
	4001	4000	u123456.7	**	MWh	
	4001	40000	u123456.7	**	MWh	
40001	100000	u1234567	**	MWh		

* An additional place to the right of the decimal point is included for the calibration display in the case of a main display which can be calibrated (Q0 or Q9). And thus the leading digit is eliminated in the case of an 8-place display.

** In the case of Q1, the secondary display can be calibrated $\hat{=}$ Q0, for which reason display overflow is based on the secondary display. The normal display is shifted one place to the left if necessary.

6.3 Meanings of Symbols at the LCD

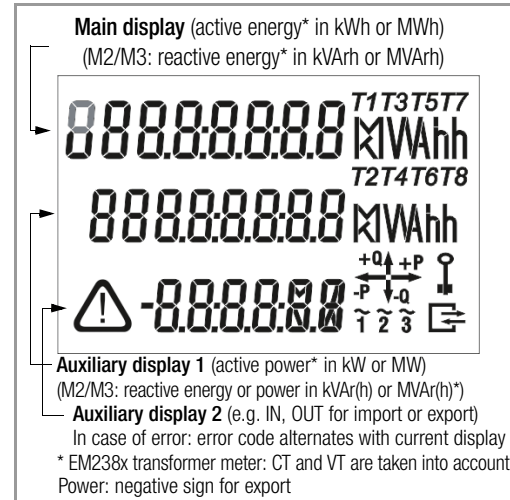

Main display, not calibrated (feature Q1, programmable CT/VT, see section 6.2).
T1 ... T8: active tariff

Display of instantaneous power in 4 quadrants: positive or negative active power P, positive or negative reactive power Q.

Correct connection: Continuous illumination of the phase symbols where P ≥ 0

Phase failure: Symbol for affected phase is cleared from the display.

Incorrect phase sequence: Phase symbols blink in following order: 3 - 2 - 1.

Negative power: Respective phase symbol blinks.

For bus connection: appears when the meter transmits a data packet.

Key symbols for parameters configuration (see next column)

Key Symbols for Parameters Configuration

for Feature Q1 and V2, V4:

Key and 2nd key bit blanked: Parameter CT, VT and S0 configurable according to features, disabling with enable key.

Key displayed with one bit: Parameter CT, VT and S0 disabled, change after activating the enable key.

Remaining feature combinations:

Key blanked, 2nd key bit displayed: parameters CT, VT or S0 (which are or can be calibrated) are preset at the factory, can be queried in the display mode, other parameters can be set by the user.

Key displayed with 2nd bit: parameters which are or can be calibrated are preset at the factory; other parameters are disabled with the enable key and must be reset after clearing disabling.

Values which are preset at the factory are printed additionally on the rating plate.

6.4 LCD Background Illumination

Background illumination is activated each time a key is activated. Background illumination goes off after about 2 minutes.

Background illumination colors indicate various display menus:

- White: query menus
- Red: display of firmware version
- Pink: parameters display and setting menu
- Blinking red: in case of error

6.5 Key Operation

Querying Parameter Values

In addition to the LCD test, the UP and ENTER keys also make it possible to query currently set parameter values, as well as to change parameters for certain features after first pressing the enable key.

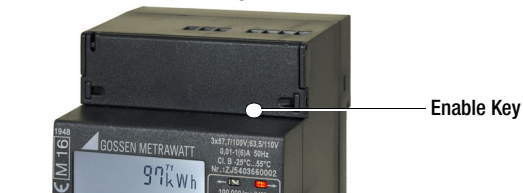

If no keys are pressed for a period of 1 minute, the meter is returned automatically to its standard display.

Parameters can be changed for the following meters:

Parameters CT and VT for U238x with feature Q1, Parameter S0 for U228x/U238x with feature V2/V4
Further parameters in accordance with interface description.

a) Enabling Parameter Changes

The enable key makes it possible to enable or disable parameter changes. It's located underneath the top terminal cover between terminals 21 and 22 and is activated with a pointed object (e.g. a ballpoint pen).

Pressing the enable key activates the "change parameters" operating mode (key off):



Pressing the enable key again disables the "change parameters" operating mode (key on):

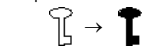

If no keys are pressed for a period of about 2 minutes, the "change parameters" operating mode is exited automatically and disabled (key on).

b) Changing Parameter Values

Briefly press the enabling key as described in point a) above (this activates the "change parameters" operating mode).

See the operating overview on the back with regard to changing the parameters.

Press and hold the ENTER key until the firmware version appears (red background).

Press the UP key. The display test appears. Briefly press and hold the ENTER key in order to display two further test patterns.

Press the UP key. The display test appears. Briefly press and hold the ENTER key in order to display two further test patterns.

Then repeatedly press the UP key until the parameter to be changed appears at the display.

Briefly press the ENTER key in order to access the setting menu.

The input cursor blinks at the leftmost entry position. Each time the ENTER key is pressed the cursor is advanced to the next position to the right. The value of the blinking digit can be increased by pressing the UP key. When the rightmost digit is acknowledged by pressing the ENTER key, the selected value is accepted and SAVInG appears briefly at auxiliary display 2. If no keys are pressed for a period of about one minute, the setting menu is exited.

Press and hold the ENTER key or wait for one minute in order to change to the normal display.

Press the enable key once again. This disables the "change parameters" operating mode. Disabling takes place automatically after 2 minutes.

7 Switching Amongst Tariffs

Hardware Controlled

Tariff Input	Tb	Ta
Tariff 1	0	0
Tariff 2	0	1
Tariff 3	1	0
Tariff 4	1	1

Tariff inputs Ta and Tb are each connected with reference to Tn.

Level 0: < 12 V

Level 1: > 45 V (max. 265 V permissible!)

Software Controlled (not included in MID scope of approval)

In the case of meters with bus (feature W1 ... W7), four further tariffs can be selected (software controlled).

8 Overview of Bus Systems

- LON-Bus (feature W1)
- M-Bus (feature W2)
- Modbus TCP (feature W4)
- Modbus RTU (feature W7)

Interface descriptions for energy meters with bus connection can be found on the Internet at www.gossenmetrawatt.com.

9 Error Messages – Reset

Display

If an error occurs, the respective error code and active energy or instantaneous power are displayed alternately.

Error Code	Meaning	Cause / Remedy
LOVOLT	Phase voltage < 75%	Check connection
UH _i 1	Maximum value for U1 exceeded	Check connection
UH _i 2	Maximum value for U2 exceeded	Check connection
UH _i 3	Maximum value for U3 exceeded	Check connection
IH _i 1	Maximum value for I1 exceeded	Check connection
IH _i 2	Maximum value for I2 exceeded	Check connection
IH _i 3	Maximum value for I3 exceeded	Check connection
SynC	Frequency measuring error	Meter connected to direct voltage
CON	Interface error	Check connection
EnErGy	Meter defective	
eRL b	Balancing required	Send device to repair service
RnRLoD	DC offset too high	

LOVOLT error

In case of LOVOLT error (phase voltages too low), background illumination, and if applicable the bus connection, are deactivated. The counter reading profile (feature Z1) cannot be viewed as long as the error is pending.

10 Repair and Recalibration

Note for Test Laboratories

Direct measuring meter: Testing is only possible with source which supply currents superimposed on voltages.

Calibration Display

Display of energy values with increased resolution can be selected for testing or calibration purposes.

- Press and hold the ENTER key once to this end. The firmware version is displayed with a red background.
- Press the UP key twice. The calibration display appears with a pink background.

See section 6.2 with regard to resolution depending on type and feature.

Recalibration can be conducted at any time by our federally approved test laboratory (EB-8) (see repair and service address on the back of the folder).

Calibration capability is valid for 8 years in Germany.

11 Manufacturer's Guarantee

The energy meters are guaranteed for a period of 3 years after shipment. The manufacturer's guarantee covers materials and workmanship. Damages resulting from use for any other than the intended purpose or operating errors, as well as any and all consequential damages, are excluded.

12 Ambient Conditions

Operating temperature range	-25 ... +55 °C
Storage temperature range	-25 ... +70 °C
Relative humidity	< 75% annual average
Elevation	to 2000 m
Deployment	Indoors
mechanical classification	M1
electromagnetic classification	E2
Protection (built-in device)	front panel: IP 51
Protection terminal area	IP20

13 Return and Environmentally Sound Disposal

The instrument is a category 9 product (monitoring and control instrument) in accordance with ElektroG (German electrical and electronic device law). This device is subject to the RoHS directive. Furthermore, we make reference to the fact that the current status in this regard can be accessed on the Internet at www.gossenmetrawatt.com by entering the search term WEEE.

We identify our electrical and electronic devices in accordance with WEEE 2012/19/EU and ElektroG using the symbol shown at the right per DIN EN 50419.

These devices may not be disposed of with the trash. Please contact our service department regarding the return of old devices.

14 Declaration of Conformity, U228x Direct conn. Meter

CE EC-KONFORMITÄTserklärung
DECLARATION OF CONFORMITY

GMC-I MESSTECHNIK

Dokument-Nr./ Document No.: 857 / 6-036 CSA Group Bayern GmbH (NB 1848) Annex MI-003
EC-Baumusterprüfbescheinigung Nr.: CE-MTP-18-B-002-MI-003

Hersteller/ Manufacturer: GMC-I MESSTECHNIK GMBH

Anschrift/ Address: Südwestpark 15
D - 90499 Nürnberg

Produktbezeichnung/ Product name: Mehrtarif-Energiezähler, Direktanschluss
multi-rate energy meter, direct connection

EnergymID

Typ / Type: U2281/U2289

Bestell-Nr. / Order No.: U2281/U2289

Das bezeichnete Produkt stimmt mit den Vorschriften folgender Europäischer Richtlinien überein, nachgewiesen durch die vollständige Einhaltung folgender Normen:
The above mentioned product has been manufactured according to the regulations of the following European directives proven through complete compliance with the following standards:

Nr. / No.	Richtlinie	Directive
2014/32/EU	Messgeräte, Elektrozähler für Wirkverbrauch (MI-003)	Measuring instruments, active electrical energy meters (MI-003)
	MID Richtlinie - Anbringung der CE-Kennzeichnung : 2016	MID Directive - Attachment of CE mark : 2016
EN 50470-1/Be1 : 2007	IEC/Deutsche Norm	VDE-Klassifikation/Classification
EN 50470-3 : 2006		VDE 0418-0-1/Be1 : 2008 VDE 0418-0-3 : 2007

Grundnorm / Generic Standard: EN 50470-1/Be1 : 2007

Nürnberg, den: 08.06.2017
Ort, Datum / Place, date:

Geschäftsführung / managing director

Das Erzeugnis entspricht der Beschreibung mit den genannten Risiken, wenn es gemäß den Gebrauchsanweisungen und den Sicherheitsvorschriften verwendet wird.
The declaration certifies compliance with the above mentioned standards but does not include any liability for damages. The only way given to the product manufacturer, when used in full of the supply, must be observed.

© GMC-I MESSTECHNIK GmbH 2017 - Nürnberg, POFB3 - 1038 - Date: 08.06.2017 Seite 02 von 02

15 Declaration of Conformity, U238x Transformer Meter

CE EC-KONFORMITÄTserklärung
DECLARATION OF CONFORMITY

GMC-I MESSTECHNIK

Dokument-Nr./ Document No.: 857 / 6-032 CSA Group Bayern GmbH (NB 1848) Annex MI-003
EC-Baumusterprüfbescheinigung Nr.: CE-MTP-18-B-004-MI-003

Hersteller/ Manufacturer: GMC-I MESSTECHNIK GMBH

Anschrift/ Address: Südwestpark 15
D - 90499 Nürnberg

Produktbezeichnung/ Product name: Mehrtarif-Energiezähler
multi-rate energy meter

EnergymID

Typ / Type: U2381/U2387/U2389

Bestell-Nr. / Order No.: U2381/U2387/U2389

Das bezeichnete Produkt stimmt mit den Vorschriften folgender Europäischer Richtlinien überein, nachgewiesen durch die vollständige Einhaltung folgender Normen:
The above mentioned product has been manufactured according to the regulations of the following European directives proven through complete compliance with the following standards:

Nr. / No.	Richtlinie	Directive
2014/32/EU	Messgeräte, Elektrozähler für Wirkverbrauch (MI-003)	Measuring instruments, active electrical energy meters (MI-003)
	MID Richtlinie - Anbringung der CE-Kennzeichnung : 2016	MID Directive - Attachment of CE mark : 2016
EN 50470-1/Be1 : 2007	IEC/Deutsche Norm	VDE-Klassifikation/Classification
EN 50470-3 : 2006		VDE 0418-0-1/Be1 : 2008 VDE 0418-0-3 : 2007

Grundnorm / Generic Standard: EN 50470-1/Be1 : 2007

Nürnberg, den: 14.04.2016
Ort, Datum / Place, date:

Geschäftsführung / managing director

Das Erzeugnis entspricht der Beschreibung mit den genannten Risiken, wenn es gemäß den Gebrauchsanweisungen und den Sicherheitsvorschriften verwendet wird.
The declaration certifies compliance with the above mentioned standards but does not include any liability for damages. The only way given to the product manufacturer, when used in full of the supply, must be observed.

© GMC-I MESSTECHNIK GmbH 2017 - Nürnberg, POFB3 - 1038 - Date: 14.04.2016 Seite 02 von 02

Operating Overview

Switching Between Active and Reactive Energy – Display Tests – Calibration Display – Setting Transformer and S0 Interface Parameters

Normal display: Active energy import, Active power import, Reactive energy, inductive (M2/M3 only), Reactive power, inductive (M2/M3 only), Active energy export, Active power export, Reactive energy, capacitive (M2/M3 only), Reactive power, capacitive (M2/M3 only), Active energy import, total, Reactive energy import, total (M2/M3 only), Active energy export, total, Reactive energy export, total (M2/M3)

Active tariff (here T1): Tariff (T1), Tariff (T2), Tariff (T3), Tariff (T4)

Power displays M1/M3 only: Active power / phase, Apparent power / phase, Power factor / phase, Power factor

Mains monitor M1/M3 only: Phase voltages, Line-to-line voltage, Phase currents, THD U1, U2, U3, THD I1, I2, I3

Counter reading profile feature Z1 only (only with bus feature: W1 ... W7): Query counter reading profile, Set counter reading profile, Normal display, Setting menu, increment, Set demand integration period

Abbreviations: ct (Transformation ratio, current), I_N (N conductor current (calculated)), S0 (S0 pulse output), THD (Distortion component (for voltage and current)), vt (Transformation ratio, voltage)

Features: M1 (Multifunctional variant: measurement of U, I, P, Q, S, PF, f, THD, In), M2 (Measurement of reactive energy), M3 (Multifunctional variant: measurement of U, I, P, Q, S, PF, f, THD, In, reactive energy), Q1 (Programmable transformation ratios), Q9 (Fixed transformation ratios), V2/V4 (Programmable S0), V9 (Customer-specific S0 rate), W1 ... 7 (Bus connections), Z1 (Counter reading profile (only possible with bus))

Measuring Function	Accuracy	(Display) Feature
Active energy (kWh) ¹	EP1...EP8, EPtot ±1%	M0, M1, M2 ² , M3 ²
Reactive energy (kVarh)	EQ1...EQ8, EQtot ±2%	
Star voltage (V)	U1 _N , U2 _N , U3 _N 0.5% ±1 d	
Delta voltage (V)	U12, U23, U13 0.5% ±1 d	
Current per phase (A)	I1, I2, I3 0.5% ±1 d	
N conductor current (A)	I _N 1% ±1 d, typ.	
Active power (kW)	P1, P2, P3, Ptot 1% ±1 d	
Reactive energy (kVar)	Q1, Q2, Q3, Qtot 1% ±1 d	
Apparent power (kVA)	S1, S2, S3, Stot 1% ±1 d	
Power factor (cos phi)	PF1, PF2, PF3, PFtot 1% ±1 d	
Frequency (Hz)	f 0.05% ±1 d	
RMS distortion value	THD U1, U2, U3 THD I1, I2, I3	

1 Total active power (kW) appears at auxiliary display 2
2 Not approved for billing purposes in Switzerland

** See corresponding interface description for additional menus in case of bus connections (feature W1 ... W7) – set counter reading profile (Z1) can be found underneath query counter reading profile.